

PLATEAUX DU : 04 AVRIL

HEURE : 14h00

LIEU : NITRY

**PLACEMENT DES ÉQUIPES  
(DÉPART DU PLATEAU)**

← Descente Montée →

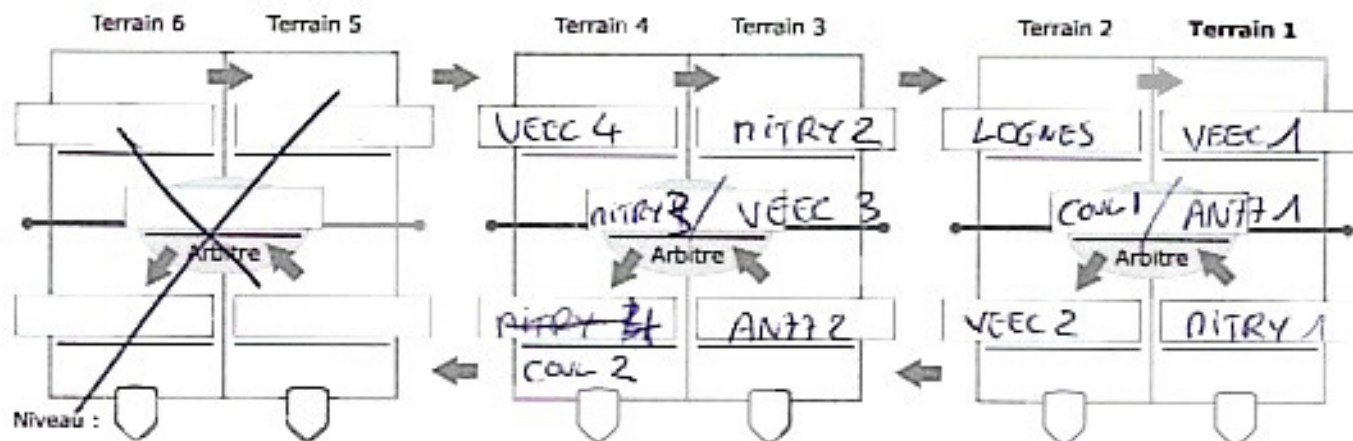
**DÉROULEMENT DU PLATEAU**

PHASE 1 : \_\_ matchs de \_\_ minutes : [1][2][3][4][5][6][7][8]

pause de 5'

PHASE 2 : \_\_ matchs en \_\_ pts max (1ère équipe à 15 pts, 2 pts d'écart) : [1][2][3][4][5][6][7][8]

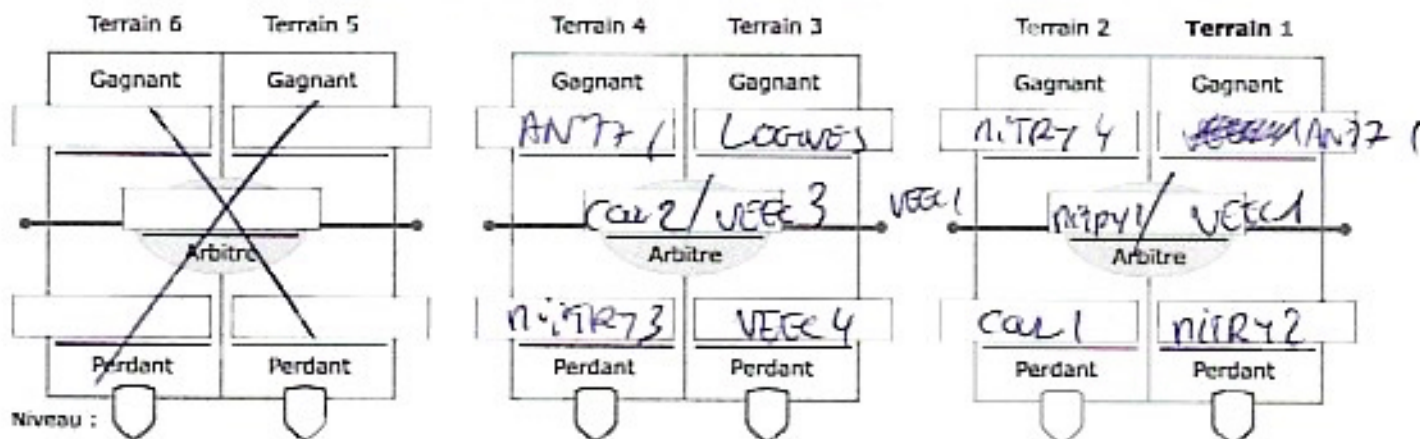
**RÉSULTATS**
**(FIN DU PLATEAU)** Lancer le dernier match puis à l'issue de ce dernier match, inscrire les résultats ci-dessous :

**Exemples d'organisation**

← Descente Montée →

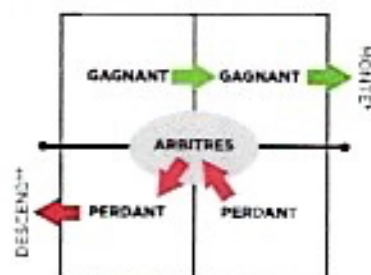
	Filet 1		Filet 2		Filet 3	
	Terrain 6	Terrain 5	Terrain 4	Terrain 3	Terrain 2	Terrain 1
<b>13 équipes</b>	ÉQUIPE 1 ÉQUIPE 2 ARBITRE : ÉQUIPE 3	ÉQUIPE 3 ÉQUIPE 4	ÉQUIPE 6 ÉQUIPE 7 ARBITRE : ÉQUIPE 10	ÉQUIPE 8 ÉQUIPE 9	ÉQUIPE 11 ÉQUIPE 12 ARR. : ÉQUIPE 13	
<b>14 équipes</b>	ÉQUIPE 1 ARBITRE : ÉDUCATEURS	ÉQUIPE 3 ÉQUIPE 4	ÉQUIPE 6 ÉQUIPE 8 ARBITRE : ÉQUIPE 9	ÉQUIPE 7 ÉQUIPE 9	ÉQUIPE 10 ÉQUIPE 11 ARBITRE : ÉQUIPE 14	ÉQUIPE 12 ÉQUIPE 13
<b>15 équipes</b>	ÉQUIPE 1 ARBITRE : ÉQUIPE 5	ÉQUIPE 3 ÉQUIPE 4	ÉQUIPE 6 ÉQUIPE 7 ARBITRE : ÉQUIPE 10	ÉQUIPE 8 ÉQUIPE 9	ÉQUIPE 11 ÉQUIPE 12 ARBITRE : ÉQUIPE 15	ÉQUIPE 13 ÉQUIPE 14

**Formule sportive**

 \* MONTÉE OU RESTE SUR TERRAIN LE PLUS FORT  
 \*\* DESCENTE OU RESTE SUR TERRAIN LE PLUS FAIBLE

 Les feuilles de résultats et les compositions d'équipes devront être envoyées au plus tard le lendemain du plateau à : [plateauxdematches@cdvb77.fr](mailto:plateauxdematches@cdvb77.fr)

Commentaires :

Date :

Responsable du plateau :

Signature :



DATE : 04/04/2026

Page \_\_\_\_ SUR \_\_\_\_ (si plus de 8 équipes)

LIEU : MITRY-MORY

**CLUB** (en toutes lettres) : COULOMMIERS BRIE

**ÉDUCATEUR**: BOURJOT Nathalie































**SIGNATURE** :

**LICENCE** : 0945896



**Cette fiche est à remettre au club organisateur dès votre arrivée au plateau de match.**
**RAPPEL :**

Les équipes sont composées de 2 joueur(euse)s maximum !

Pas de remplaçant, sauf si le club est représenté par un nombre impair de joueurs. Dans ce cas une seule équipe de 3 joueurs sera acceptée.

ÉQUIPE :	<input type="radio"/>  <input type="radio"/>  A <input type="radio"/>  B	NOM - PRENOM	LICENCE
1	<input type="radio"/>  <input type="radio"/>  A <input type="radio"/>  B	ROUAB MOLLICAONE Freya	2880450
		CAROVILLANO Nicola	2787905
2	<input type="radio"/>  <input type="radio"/>  A <input type="radio"/>  B	MERGOT Sélène	2888189
		RODRIGUE Julian	2900105
	<input type="radio"/>  <input type="radio"/>  A <input type="radio"/>  B		
	<input type="radio"/>  <input type="radio"/>  A <input type="radio"/>  B		
	<input type="radio"/>  <input type="radio"/>  A <input type="radio"/>  B		
	<input type="radio"/>  <input type="radio"/>  A <input type="radio"/>  B		
	<input type="radio"/>  <input type="radio"/>  A <input type="radio"/>  B		
	<input type="radio"/>  <input type="radio"/>  A <input type="radio"/>  B		
<b>Joueur(euse)s supplémentaire(s) :</b> (NOMBRE IMPAIR DE JOUEUR, MAXIMUM 1 PAR PLATEAU)			
ÉQUIPE :	<input type="radio"/> 	MOGLIACCI Ana	2677332
ÉQUIPE :	2 <input checked="" type="radio"/>  A		
ÉQUIPE :	<input type="radio"/>  B		

Dans le cas d'une équipe composée de 2 enfants de clubs différents :

ÉQUIPE :	<input type="radio"/>  <input type="radio"/>  A <input type="radio"/>  B	NOM - PRENOM	LICENCE

**CLUB** :

DATE : 04/04/26

 Page 1 sur 1 (si plus de 8 équipes)

LIEU : MITRY MORY

**CLUB** (en toutes lettres) : US LOGNES VOLLEY BALL

**ÉDUCATEUR** : Noémie CANTET

**SIGNATURE** :

**LICENCE** : 2243283

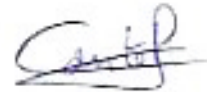
**Cette fiche est à remettre au club organisateur dès votre arrivée au plateau de match.**
**RAPPEL :**

Les équipes sont composées de 2 joueur(euse)s maximum !

Pas de remplaçant, sauf si le club est représenté par un nombre impair de joueurs. Dans ce cas une seule équipe de 3 joueurs sera acceptée.

ÉQUIPE : <input type="text"/>	<input type="radio"/>	<input checked="" type="radio"/>	<input type="radio"/>	<input type="radio"/>	<input type="radio"/>	<input type="radio"/>	<input type="radio"/>	NOM - PRENOM	LICENCE
								FOSSEN JULIA	2881279
								LEMONY LUNA	2078638

ÉQUIPE : <input type="text"/>	<input type="radio"/>	<input checked="" type="radio"/>	<input type="radio"/>	<input type="radio"/>	<input type="radio"/>	<input type="radio"/>	<input type="radio"/>	NOM - PRENOM	LICENCE

ÉQUIPE : <input type="text"/>	<input type="radio"/>	<input checked="" type="radio"/>	<input type="radio"/>	<input type="radio"/>	<input type="radio"/>	<input type="radio"/>	<input type="radio"/>	NOM - PRENOM	LICENCE

ÉQUIPE : <input type="text"/>	<input type="radio"/>	<input checked="" type="radio"/>	<input type="radio"/>	<input type="radio"/>	<input type="radio"/>	<input type="radio"/>	<input type="radio"/>	NOM - PRENOM	LICENCE

ÉQUIPE : <input type="text"/>	<input type="radio"/>	<input checked="" type="radio"/>	<input type="radio"/>	<input type="radio"/>	<input type="radio"/>	<input type="radio"/>	<input type="radio"/>	NOM - PRENOM	LICENCE

ÉQUIPE : <input type="text"/>	<input type="radio"/>	<input checked="" type="radio"/>	<input type="radio"/>	<input type="radio"/>	<input type="radio"/>	<input type="radio"/>	<input type="radio"/>	NOM - PRENOM	LICENCE

ÉQUIPE : <input type="text"/>	<input type="radio"/>	<input checked="" type="radio"/>	<input type="radio"/>	<input type="radio"/>	<input type="radio"/>	<input type="radio"/>	<input type="radio"/>	NOM - PRENOM	LICENCE

ÉQUIPE : <input type="text"/>	<input type="radio"/>	<input checked="" type="radio"/>	<input type="radio"/>	<input type="radio"/>	<input type="radio"/>	<input type="radio"/>	<input type="radio"/>	NOM - PRENOM	LICENCE

**Joueur(euse)s supplémentaire(s) :**

SI NOMBRE IMPAIR DE JOUEUR, MAXIMUM 1 PAR PLATEAU !

ÉQUIPE : <input type="text"/>	<input type="radio"/>	<input checked="" type="radio"/>	<input type="radio"/>	<input type="radio"/>	<input type="radio"/>	<input type="radio"/>	<input type="radio"/>	NOM - PRENOM	LICENCE

ÉQUIPE : <input type="text"/>	<input type="radio"/>	<input type="radio"/>	<input checked="" type="radio"/>	<input type="radio"/>	<input type="radio"/>	<input type="radio"/>	<input type="radio"/>	NOM - PRENOM	LICENCE

ÉQUIPE : <input type="text"/>	<input type="radio"/>	<input type="radio"/>	<input type="radio"/>	<input checked="" type="radio"/>	<input type="radio"/>	<input type="radio"/>	<input type="radio"/>	NOM - PRENOM	LICENCE

Dans le cas d'une équipe composée de 2 enfants de clubs différents :

ÉQUIPE : <input type="text"/>	<input type="radio"/>	<input checked="" type="radio"/>	<input type="radio"/>	<input type="radio"/>	<input type="radio"/>	<input type="radio"/>	<input type="radio"/>	NOM - PRENOM	LICENCE

CLUB :





**CLUB** (en toutes lettres) : U. S. J. MITRY VB



ÉDUCATEUR: DE BUE Antony



SIGNATURE :



LICENCE : 2805035

**Cette fiche est à remettre au club organisateur dès votre arrivée au plateau de match.**
**RAPPEL :**
**Les équipes sont composées de 2 joueur(euse)s maximum !**
**Pas de remplaçant, sauf si le club est représenté par un nombre impair de joueurs. Dans ce cas une seule équipe de 3 joueurs sera acceptée.**



ÉQUIPE :	<input type="radio"/>  <input checked="" type="radio"/>  <input type="radio"/>  A <input type="radio"/>  B	NOM - PRENOM	LICENCE
1		FERNANDES Tino	2699132
		HAROUKH MATANE	2792233

ÉQUIPE :	<input type="radio"/>  <input checked="" type="radio"/>  A <input type="radio"/>  B	NOM - PRENOM	LICENCE
2		BRAHMI Ismail	2896651
		LEPREUX MOREIRA Mathias	2714503

ÉQUIPE :	<input type="radio"/>  <input checked="" type="radio"/>  A <input type="radio"/>  B	NOM - PRENOM	LICENCE
3		BENKRAMA Sabrina	2884080
		REIBEL Will	2890816

ÉQUIPE :	<input type="radio"/>  <input checked="" type="radio"/>  A <input type="radio"/>  B	NOM - PRENOM	LICENCE
4		YOUSFI Nahil	2695950
		BREDILLON Loucliana	2881633

ÉQUIPE :	<input type="radio"/>  <input type="radio"/>  A <input type="radio"/>  B	NOM - PRENOM	LICENCE

ÉQUIPE :	<input type="radio"/>  <input type="radio"/>  A <input type="radio"/>  B	NOM - PRENOM	LICENCE

ÉQUIPE :	<input type="radio"/>  <input type="radio"/>  A <input type="radio"/>  B	NOM - PRENOM	LICENCE

ÉQUIPE :	<input type="radio"/>  <input type="radio"/>  A <input type="radio"/>  B	NOM - PRENOM	LICENCE



**Joueur(euse)s supplémentaire(s) :**
5 NOMBRES IMPAIRS DE JOUEUR MAXIMUM PAR PLATEAU

ÉQUIPE :	<input type="radio"/> 	NOM - PRENOM	LICENCE

ÉQUIPE :	<input type="radio"/>  A	NOM - PRENOM	LICENCE

ÉQUIPE :	<input type="radio"/>  B	NOM - PRENOM	LICENCE

**Dans le cas d'une équipe composée de 2 enfants de clubs différents :**

ÉQUIPE :	<input type="radio"/>  <input type="radio"/>  A <input type="radio"/>  B	NOM - PRENOM	LICENCE

CLUB :

DATE : 04/04/2026

Page 1 sur 1 (si plus de 8 équipes)

LIEU : MITRY

**CLUB** (en toutes lettres) : ALLANCE NORD 77 VB

**ÉDUCATEUR**: Manuel Geslin

SIGNATURE :

**LICENCE** : 1131080

**Cette fiche est à remettre au club organisateur dès votre arrivée au plateau de match.**
**RAPPEL :**
**Les équipes sont composées de 2 joueur(euse)s maximum !**
**Pas de remplaçant, sauf si le club est représenté par un nombre impair de joueurs. Dans ce cas une seule équipe de 3 joueurs sera acceptée.**

ÉQUIPE :		NOM - PRENOM	LICENCE
1	<input type="radio"/> <input checked="" type="radio"/> <input type="radio"/> A <input type="radio"/> B	Gabriel Pavot	2884181
		Alexandre Parshad	2884650
2	<input type="radio"/> <input checked="" type="radio"/> <input type="radio"/> A <input type="radio"/> B	Mandy Cols	2899544
		Lea Azout	2891817
	<input type="radio"/> <input type="radio"/> <input type="radio"/> A <input type="radio"/> B		
	<input type="radio"/> <input type="radio"/> <input type="radio"/> A <input type="radio"/> B		
	<input type="radio"/> <input type="radio"/> <input type="radio"/> A <input type="radio"/> B		
	<input type="radio"/> <input type="radio"/> <input type="radio"/> A <input type="radio"/> B		
	<input type="radio"/> <input type="radio"/> <input type="radio"/> A <input type="radio"/> B		
	<input type="radio"/> <input type="radio"/> <input type="radio"/> A <input type="radio"/> B		
	<input type="radio"/> <input type="radio"/> <input type="radio"/> A <input type="radio"/> B		
	<input type="radio"/> <input type="radio"/> <input type="radio"/> A <input type="radio"/> B		
	<input type="radio"/> <input type="radio"/> <input type="radio"/> A <input type="radio"/> B		
	<input type="radio"/> <input type="radio"/> <input type="radio"/> A <input type="radio"/> B		
	<input type="radio"/> <input type="radio"/> <input type="radio"/> A <input type="radio"/> B		
	<input type="radio"/> <input type="radio"/> <input type="radio"/> A <input type="radio"/> B		
	<input type="radio"/> <input type="radio"/> <input type="radio"/> A <input type="radio"/> B		
	<input type="radio"/> <input type="radio"/> <input type="radio"/> A <input type="radio"/> B		
	<input type="radio"/> <input type="radio"/> <input type="radio"/> A <input type="radio"/> B		
	<input type="radio"/> <input type="radio"/> <input type="radio"/> A <input type="radio"/> B		
	<input type="radio"/> <input type="radio"/> <input type="radio"/> A <input type="radio"/> B		
	<input type="radio"/> <input type="radio"/> <input type="radio"/> A <input type="radio"/> B		
	<input type="radio"/> <input type="radio"/> <input type="radio"/> A <input type="radio"/> B		
	<input type="radio"/> <input type="radio"/> <input type="radio"/> A <input type="radio"/> B		
	<input type="radio"/> <input type="radio"/> <input type="radio"/> A <input type="radio"/> B		
	<input type="radio"/> <input type="radio"/> <input type="radio"/> A <input type="radio"/> B		
	<input type="radio"/> <input type="radio"/> <input type="radio"/> A <input type="radio"/> B		
	<input type="radio"/> <input type="radio"/> <input type="radio"/> A <input type="radio"/> B		
	<input type="radio"/> <input type="radio"/> <input type="radio"/> A <input type="radio"/> B		
	<input type="radio"/> <input type="radio"/> <input type="radio"/> A <input type="radio"/> B		
	<input type="radio"/> <input type="radio"/> <input type="radio"/> A <input type="radio"/> B		
	<input type="radio"/> <input type="radio"/> <input type="radio"/> A <input type="radio"/> B		
	<input type="radio"/> <input type="radio"/> <input type="radio"/> A <input type="radio"/> B		
	<input type="radio"/> <input type="radio"/> <input type="radio"/> A <input type="radio"/> B		
	<input type="radio"/> <input type="radio"/> <input type="radio"/> A <input type="radio"/> B		
	<input type="radio"/> <input type="radio"/> <input type="radio"/> A <input type="radio"/> B		
	<input type="radio"/> <input type="radio"/> <input type="radio"/> A <input type="radio"/> B		
	<input type="radio"/> <input type="radio"/> <input type="radio"/> A <input type="radio"/> B		
	<input type="radio"/> <input type="radio"/> <input type="radio"/> A <input type="radio"/> B		
	<input type="radio"/> <input type="radio"/> <input type="radio"/> A <input type="radio"/> B		
	<input type="radio"/> <input type="radio"/> <input type="radio"/> A <input type="radio"/> B		
	<input type="radio"/> <input type="radio"/> <input type="radio"/> A <input type="radio"/> B		
	<input type="radio"/> <input type="radio"/> <input type="radio"/> A <input type="radio"/> B		
	<input type="radio"/> <input type="radio"/> <input type="radio"/> A <input type="radio"/> B		
	<input type="radio"/> <input type="radio"/> <input type="radio"/> A <input type="radio"/> B		
	<input type="radio"/> <input type="radio"/> <input type="radio"/> A <input type="radio"/> B		
	<input type="radio"/> <input type="radio"/> <input type="radio"/> A <input type="radio"/> B		
	<input type="radio"/> <input type="radio"/> <input type="radio"/> A <input type="radio"/> B		
	<input type="radio"/> <input type="radio"/> <input type="radio"/> A <input type="radio"/> B		
	<input type="radio"/> <input type="radio"/> <input type="radio"/> A <input type="radio"/> B		
	<input type="radio"/> <input type="radio"/> <input type="radio"/> A <input type="radio"/> B		
	<input type="radio"/> <input type="radio"/> <input type="radio"/> A <input type="radio"/> B		
	<input type="radio"/> <input type="radio"/> <input type="radio"/> A <input type="radio"/> B		
	<input type="radio"/> <input type="radio"/> <input type="radio"/> A <input type="radio"/> B		
	<input type="radio"/> <input type="radio"/> <input type="radio"/> A <input type="radio"/> B		
	<input type="radio"/> <input type="radio"/> <input type="radio"/> A <input type="radio"/> B		
	<input type="radio"/> <input type="radio"/> <input type="radio"/> A <input type="radio"/> B		
	<input type="radio"/> <input type="radio"/> <input type="radio"/> A <input type="radio"/> B		
	<input type="radio"/> <input type="radio"/> <input type="radio"/> A <input type="radio"/> B		
	<input type="radio"/> <input type="radio"/> <input type="radio"/> A <input type="radio"/> B		
	<input type="radio"/> <input type="radio"/> <input type="radio"/> A <input type="radio"/> B		
	<input type="radio"/> <input type="radio"/> <input type="radio"/> A <input type="radio"/> B		
	<input type="radio"/> <input type="radio"/> <input type="radio"/> A <input type="radio"/> B		
	<input type="radio"/> <input type="radio"/> <input type="radio"/> A <input type="radio"/> B		
	<input type="radio"/> <input type="radio"/> <input type="radio"/> A <input type="radio"/> B		
	<input type="radio"/> <input type="radio"/> <input type="radio"/> A <input type="radio"/> B		
	<input type="radio"/> <input type="radio"/> <input type="radio"/> A <input type="radio"/> B		
	<input type="radio"/> <input type="radio"/> <input type="radio"/> A <input type="radio"/> B		
	<input type="radio"/> <input type="radio"/> <input type="radio"/> A <input type="radio"/> B		
	<input type="radio"/> <input type="radio"/> <input type="radio"/> A <input type="radio"/> B		
	<input type="radio"/> <input type="radio"/> <input type="radio"/> A <input type="radio"/> B		
	<input type="radio"/> <input type="radio"/> <input type="radio"/> A <input type="radio"/> B		
	<input type="radio"/> <input type="radio"/> <input type="radio"/> A <input type="radio"/> B		
	<input type="radio"/> <input type="radio"/> <input type="radio"/> A <input type="radio"/> B		
	<input type="radio"/> <input type="radio"/> <input type="radio"/> A <input type="radio"/> B		
	<input type="radio"/> <input type="radio"/> <input type="radio"/> A <input type="radio"/> B		
	<input type="radio"/> <input type="radio"/> <input type="radio"/> A <input type="radio"/> B		
	<input type="radio"/> <input type="radio"/> <input type="radio"/> A <input type="radio"/> B		
	<input type="radio"/> <input type="radio"/> <input type="radio"/> A <input type="radio"/> B		
	<input type="radio"/> <input type="radio"/> <input type="radio"/> A <input type="radio"/> B		
	<input type="radio"/> <input type="radio"/> <input type="radio"/> A <input type="radio"/> B		
	<input type="radio"/> <input type="radio"/> <input type="radio"/> A <input type="radio"/> B		
	<input type="radio"/> <input type="radio"/> <input type="radio"/> A <input type="radio"/> B		
	<input type="radio"/> <input type="radio"/> <input type="radio"/> A <input type="radio"/> B		
	<input type="radio"/> <input type="radio"/> <input type="radio"/> A <input type="radio"/> B		
	<input type="radio"/> <input type="radio"/> <input type="radio"/> A <input type="radio"/> B		
	<input type="radio"/> <input type="radio"/> <input type="radio"/> A <input type="radio"/> B		
	<input type="radio"/> <input type="radio"/> <input type="radio"/> A <input type="radio"/> B		
	<input type="radio"/> <input type="radio"/> <input type="radio"/> A <input type="radio"/> B		
	<input type="radio"/> <input type="radio"/> <input type="radio"/> A <input type="radio"/> B		
	<input type="radio"/> <input type="radio"/> <input type="radio"/> A <input type="radio"/> B		
	<input type="radio"/> <input type="radio"/> <input type="radio"/> A <input type="radio"/> B		
	<input type="radio"/> <input type="radio"/> <input type="radio"/> A <input type="radio"/> B		
	<input type="radio"/> <input type="radio"/> <input type="radio"/> A <input type="radio"/> B		
	<input type="radio"/> <input type="radio"/> <input type="radio"/> A <input type="radio"/> B		
	<input type="radio"/> <input type="radio"/> <input type="radio"/> A <input type="radio"/> B		
	<input type="radio"/> <input type="radio"/> <input type="radio"/> A <input type="radio"/> B		
	<input type="radio"/> <input type="radio"/> <input type="radio"/> A <input type="radio"/> B		
	<input type="radio"/> <input type="radio"/> <input type="radio"/> A <input type="radio"/> B		
	<input type="radio"/> <input type="radio"/> <input type="radio"/> A <input type="radio"/> B		
	<input type="radio"/> <input type="radio"/> <input type="radio"/> A <input type="radio"/> B		
	<input type="radio"/> <input type="radio"/> <input type="radio"/> A <input type="radio"/> B		
	<input type="radio"/> <input type="radio"/> <input type="radio"/> A <input type="radio"/> B		
	<input type="radio"/> <input type="radio"/> <input type="radio"/> A <input type="radio"/> B		
	<input type="radio"/> <input type="radio"/> <input type="radio"/> A <input type="radio"/> B		
	<input type="radio"/> <input type="radio"/> <input type="radio"/> A <input type="radio"/> B		
	<input type="radio"/> <input type="radio"/> <input type="radio"/> A <input type="radio"/> B		
	<input type="radio"/> <input type="radio"/> <input type="radio"/> A <input type="radio"/> B		
	<input type="radio"/> <input type="radio"/> <input type="radio"/> A <input type="radio"/> B		
	<input type="radio"/> <input type="radio"/> <input type="radio"/> A <input type="radio"/> B		
	<input type="radio"/> <input type="radio"/> <input type="radio"/> A <input type="radio"/> B		
	<input type="radio"/> <input type="radio"/> <input type="radio"/> A <input type="radio"/> B		
	<input type="radio"/> <input type="radio"/> <input type="radio"/> A <input type="radio"/> B		
	<input type="radio"/> <input type="radio"/> <input type="radio"/> A <input type="radio"/> B		
	<input type="radio"/> <input type="radio"/> <input type="radio"/> A <input type="radio"/> B		
	<input type="radio"/> <input type="radio"/> <input type="radio"/> A <input type="radio"/> B		
	<input type="radio"/> <input type="radio"/> <input type="radio"/> A <input type="radio"/> B		
	<input type="radio"/> <input type="radio"/> <input type="radio"/> A <input type="radio"/> B		
	<input type="radio"/> <input type="radio"/> <input type="radio"/> A <input type="radio"/> B		
	<input type="radio"/> <input type="radio"/> <input type="radio"/> A <input type="radio"/> B		
	<input type="radio"/> <input type="radio"/> <input type="radio"/> A <input type="radio"/> B		
	<input type="radio"/> <input type="radio"/> <input type="radio"/> A <input type="radio"/> B		
	<input type="radio"/> <input type="radio"/> <input type="radio"/> A <input type="radio"/> B		
	<input type="radio"/> <input type="radio"/> <input type="radio"/> A <input type="radio"/> B		
	<input type="radio"/> <input type="radio"/> <input type="radio"/> A <input type="radio"/> B		
	<input type="radio"/> <input type="radio"/> <input type="radio"/> A <input type="radio"/> B		
	<input type="radio"/> <input type="radio"/> <input type="radio"/> A <input type="radio"/> B		
	<input type="radio"/> <input type="radio"/> <input type="radio"/> A <input type="radio"/> B		
	<input type="radio"/> <input type="radio"/> <input type="radio"/> A <input type="radio"/> B		
	<input type="radio"/> <input type="radio"/> <input type="radio"/> A <input type="radio"/> B		
	<input type="radio"/> <input type="radio"/> <input type="radio"/> A <input type="radio"/> B		
	<input type="radio"/> <input type="radio"/> <input type="radio"/> A <input type="radio"/>		

PLATEAU DU : 4 Août 2016

HEURE : 14h00

LIEU : HITRY NORY

CLUB (en toutes lettres) : Val d'Europe Esby Couvrain

ÉDUCATEUR: HATHIS VARIAN

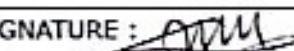
 SIGNATURE : 

LICENCE : 2517142

 PLATEAU :   19

Cette fiche est à remettre au club organisateur dès votre arrivée au plateau de match.

**RAPPEL :**

Les équipes sont composées de 2 joueur(euse)s maximum !

Pas de remplaçant, sauf si le club est représenté par un nombre impair de joueurs. Dans ce cas une seule équipe de 3 joueurs sera acceptée.

JOUJEU(EUSE) SUPPLÉMENTAIRE	NOM - PRENOM	LICENCE	F	M
			<input type="checkbox"/>	<input type="checkbox"/>

ÉQUIPE : 1	NOM - PRENOM	LICENCE	F	M
	SIX MALO	2118011	<input type="checkbox"/>	<input checked="" type="checkbox"/>
	VALGAIRE LEWIS	2921407	<input type="checkbox"/>	<input checked="" type="checkbox"/>

ÉQUIPE : 2	NOM - PRENOM	LICENCE	F	M
	BEAUSARDA GABIN	2895539	<input type="checkbox"/>	<input checked="" type="checkbox"/>
	GIANESIN JEDEN	2800196	<input type="checkbox"/>	<input checked="" type="checkbox"/>

ÉQUIPE : 3	NOM - PRENOM	LICENCE	F	M
	KEBE ANIN DENIS	2815016	<input type="checkbox"/>	<input checked="" type="checkbox"/>
	BAUDRY LEONARD	2899390	<input type="checkbox"/>	<input checked="" type="checkbox"/>

ÉQUIPE : 4	NOM - PRENOM	LICENCE	F	M
	GHESSQUIER DENIS	2806208	<input type="checkbox"/>	<input checked="" type="checkbox"/>
	BELIN YODINE JOSHUA	2805369	<input type="checkbox"/>	<input checked="" type="checkbox"/>

ÉQUIPE :	NOM - PRENOM	LICENCE	F	M
			<input type="checkbox"/>	<input type="checkbox"/>

ÉQUIPE :	NOM - PRENOM	LICENCE	F	M
			<input type="checkbox"/>	<input type="checkbox"/>

ÉQUIPE :	NOM - PRENOM	LICENCE	F	M
			<input type="checkbox"/>	<input type="checkbox"/>

ÉQUIPE :	NOM - PRENOM	LICENCE	F	M
			<input type="checkbox"/>	<input type="checkbox"/>

ÉQUIPE :	NOM - PRENOM	LICENCE	F	M
			<input type="checkbox"/>	<input type="checkbox"/>

ÉQUIPE :	NOM - PRENOM	LICENCE	F	M
			<input type="checkbox"/>	<input type="checkbox"/>

Dans le cas d'une équipe composée de 2 enfants de clubs différents :

ÉQUIPE :	NOM - PRENOM	LICENCE	F	M
			<input type="checkbox"/>	<input type="checkbox"/>
JOUJEU(EUSE) D'UN AUTRE CLUB :			<input type="checkbox"/>	<input type="checkbox"/>
			<input type="checkbox"/>	<input type="checkbox"/>

